

MILITARY ORGANIZATION

MILITARY ORGANIZATION

1st Hour

I Need for Organization

A military organization is a group of men or units banded together to perform military functions with definite responsibilities and duties assigned each individual.

Any task that cannot be accomplished by one man working alone requires some form of organization. Each worker must have specific duties and cooperates with others under a leader.

Similar to any Team Sport the Army without organization would be an aimless mob. The Army is organized into a highly flexible force, both tactical and administrative. To win battles soldiers must be organized into teams. For example - the infantry battalion fights by combining fire, maneuver and shock action. By fire of recoilless rifles, rocket launchers, machine guns, mortars, and close support tanks and howitzers, it inflicts losses on the enemy and neutralizes his combat power; this permits the riflemen of the rifle companies to close with the enemy, thus producing the necessary shock action to complete the destruction of that enemy.

II Planning for Organization:

Every organization must have an executive or commander. He has the authority to issue any orders necessary to carry out his responsibilities.

Every individual of the organization must have clear, specifically stated duties.

Every position in the organization is designed as a stepping stone for the next higher one.

* NATIONAL SECURITY ORGANIZATION:

A.

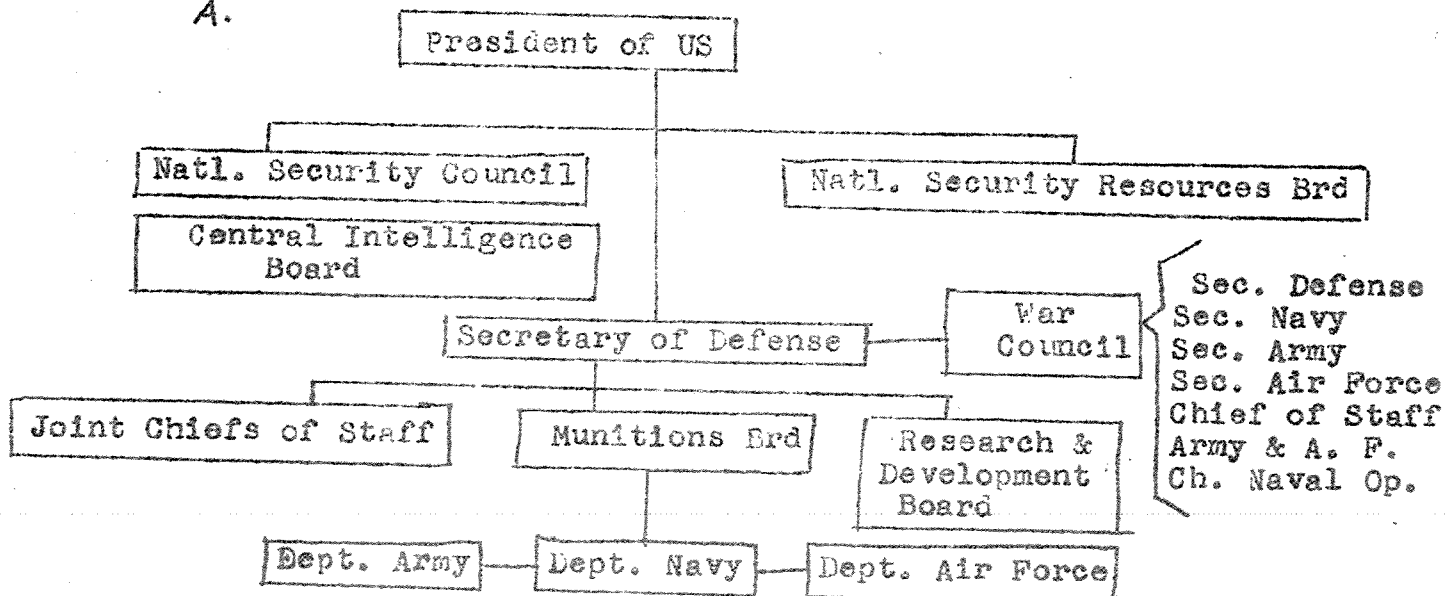

Military Organization Cont'd

B. The U.S. Army consists of three basic parts:

1. Regular Army - fulltime professional organization
2. National Guard - State Troops; formed and commanded by State Officers. In case of a major emergency may be called into Federal Control.
3. Organized Reserves - Civilian Officers and NCOs which can be called into active service in emergency

A. ROTC - Jr. and Sr. ROTC units provides Officers and NCOs for the Organized Reserves.

III The Organization Pattern

Each assigned job is given to personnel capable of performing the job, and every position in the organization is designed as a subordinate unit of the step above.

A. CHAIN OF COMMAND - U.S. ARMY

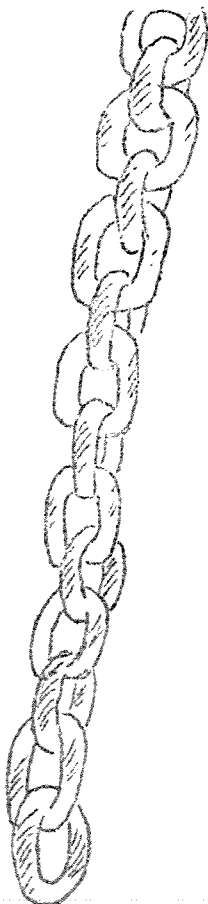

President of United States
Secretary of Defense
Secretary of the Army
The Chief of Staff
Army Commander
Corps Commander
Division Commander
Regimental Commander
Battalion Commander
Company Commander
Platoon Leader
Squad Leaders
Private - US Army

Military Organization Cont'd

IV Division of the Organization

* The Squad is the smallest organized group in the Army. The infantry squad is a nine man fighting team.

A. Organization of Rifle Company:

3 Rifle Squads & 1 Weapons Squad of 9 men each make up a RIFLE PLATOON

3 Rifle Platoons & 1 Weapons Platoon make up a RIFLE COMPANY

V Organization of RUCS Cadet Battalion

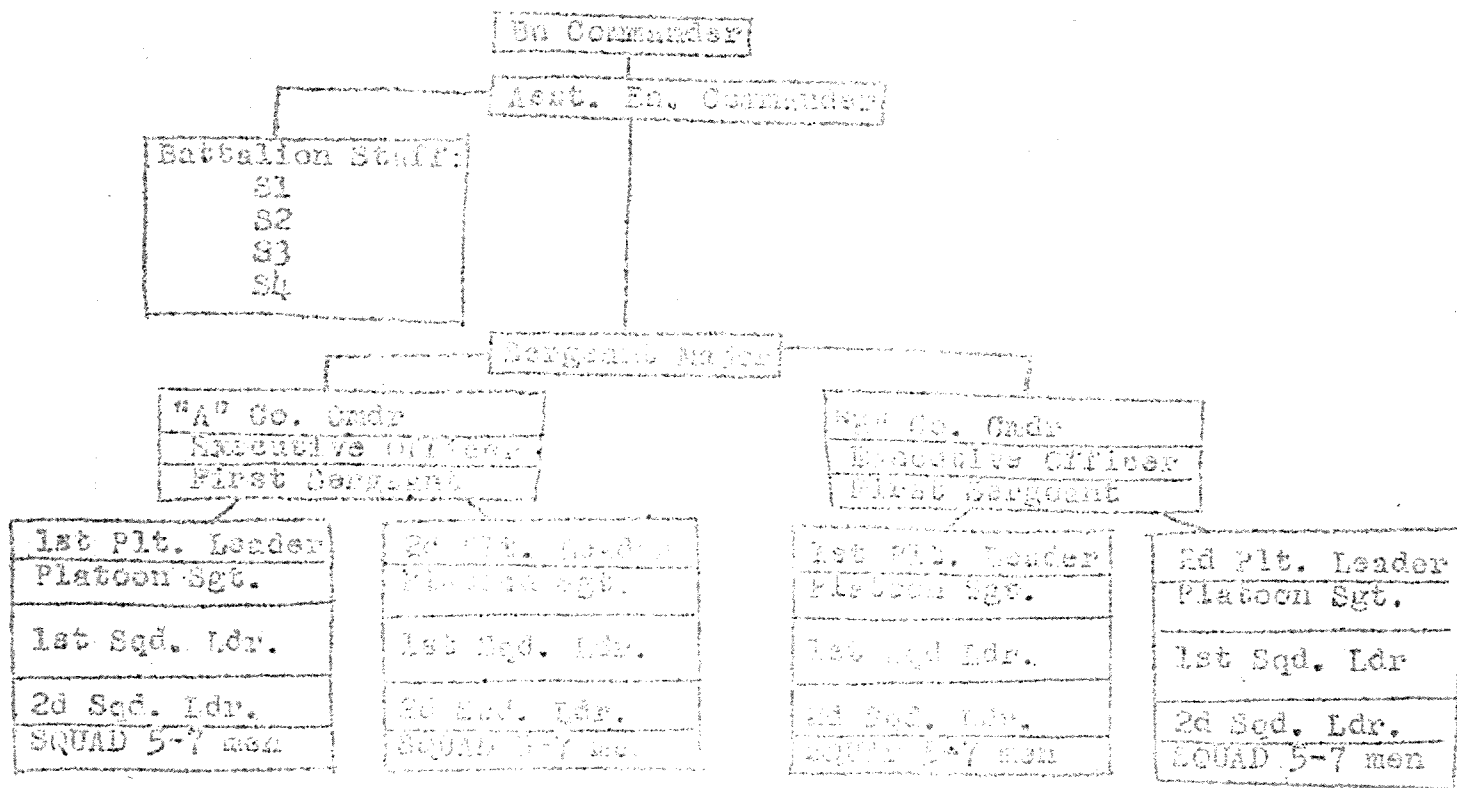

Headquarters Group:

Company Clerk
Asst. Company Clerk
Supply Sergeant
Asst. Supply Sergeant

Headquarters Group:

Company Clerk
Asst. Company Clerk
Supply Sergeant
Asst. Supply Sergeant

BASIC BATTALION ORGANIZATION

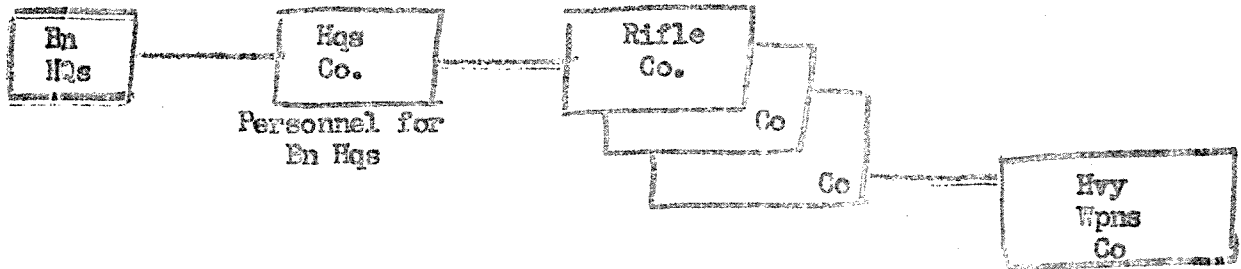

The Battalion is the smallest unit with a Staff:

Commander - Lt. Colonel

Executive Officer - Major (Is in charge of the Staff)



There are various Offs. under the Commander besides his staff:

Transportation Off.

Commun. Off.

Munitions Off.

Surgeon

Co. Cndr.

Liaison Off.

MILITARY ORGANIZATION

Company Organization - Rifle Company

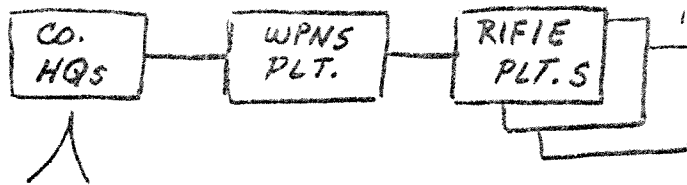

I COMMAND GROUP

Company Commander, Executive Officer, First Sergeant, Clerical Personnel

- A. Company Commander is responsible for :
 - Discipline
 - Administration
 - Supply
 - Training
 - Control of Company, all conditions at all times.....
- B. Executive Officer - Can be Platoon Leader assigned Administrative duties or whatever can be done to assist Co. Cmdr.
- C. First Sergeant - Company Commanders Enlisted Assistant. He is like a foreman. He aids in all matters pertaining to Administration of Enlisted men of the Company.
- D. Company Clerk - All administrative duties: Rosters, Personnel Records, Assists First Sergeant.
- E. Supply Sergeant - Obtains and distributes supplies needed by Company except Food.
- F. Armorer - Assists Supply Sergeant and makes minor repairs to weapons.

II Platoon Organization:

- A. Platoon Leader - Officer in command group assisting Company Commander. Is in direct command of Platoon and responsible of its discipline, control, training, etc.
- B. Platoon Sergeant - is second in command of Platoon; assisting Platoon Leader in all things.
 - a. Asst. Plt. Sgt - Same duties only to Plt. Sgt.
- C. Sqd Leader - is responsible for every member of Squad, all phases of control.
 - b. Asst. Sqd Ldr - assists Sqd Ldr and is second in command.

TANK COMPANY



OFF-5 EM-106

17 90 MM GUN TANKS

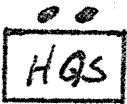
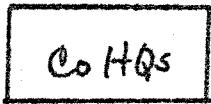

2 90MM
GUN TANKS

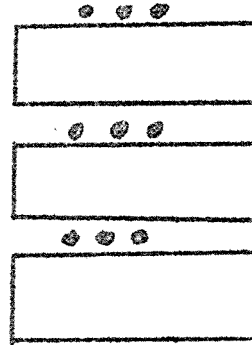

OFF-1 EM-24



5 90MM GUN TANKS

This is for your own information. It is not mandatory that you know this.

Field Art Battery



0-8 EM-121

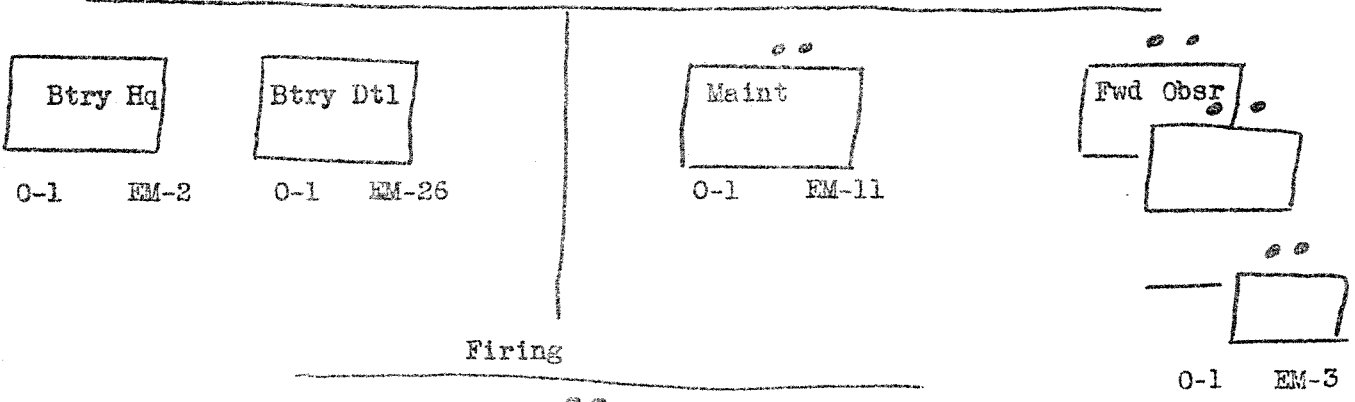

Firing

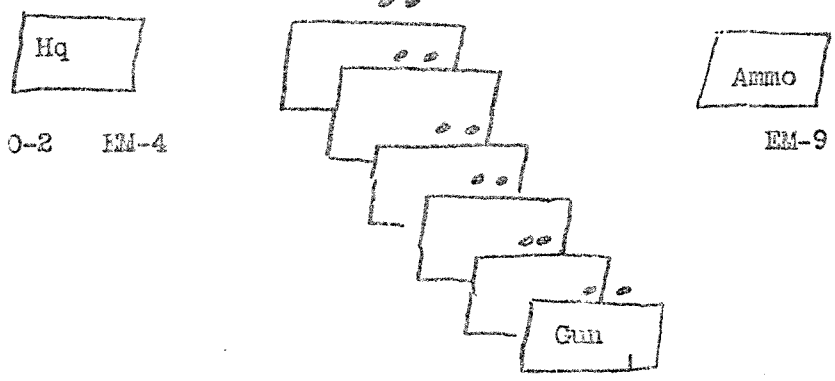

EM-10
1 How 105 MM

ORGANIZATION OF THE MILITARY

CHAIN OF COMMAND OF THE US ARMY:

- President of the United States
- Secretary of Defense
- Secretary of the Army
- Chief of Staff (Military Officer)
- Army Commanders (1958 had 6 Armies in the US)
- Corp Commanders
- Division Commanders
- Regimental Commanders
- Battalion Commanders
- Company Commanders
- Platoon Leaders
- Squad Leaders
- Recruit

SYMBOLS TO BE REMEMBERED:

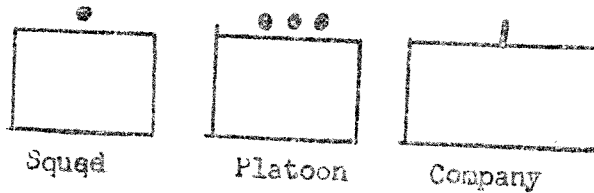

Organization of Cadet Platoon

The Cadet Platoon contains two or three squads and a small HQ to provide control and coordination.



Organization of the Army Rifle Platoon

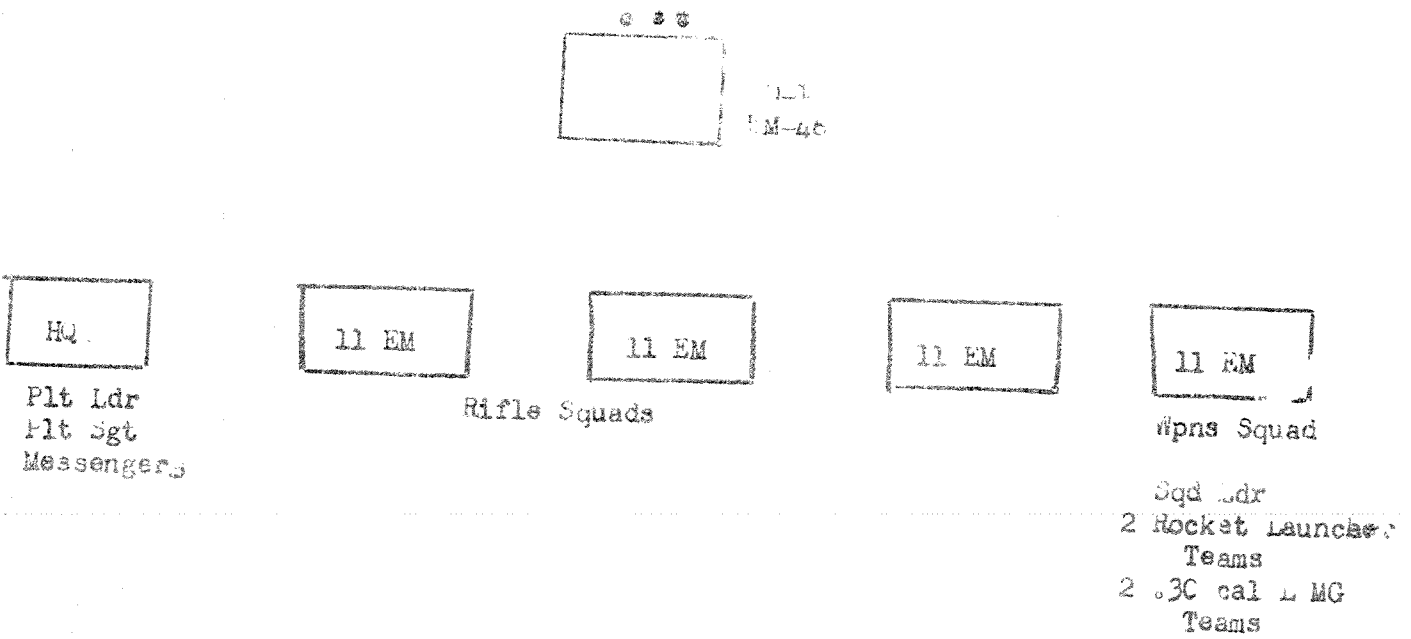

Military Organization cont'd

Organization of Cadet Company

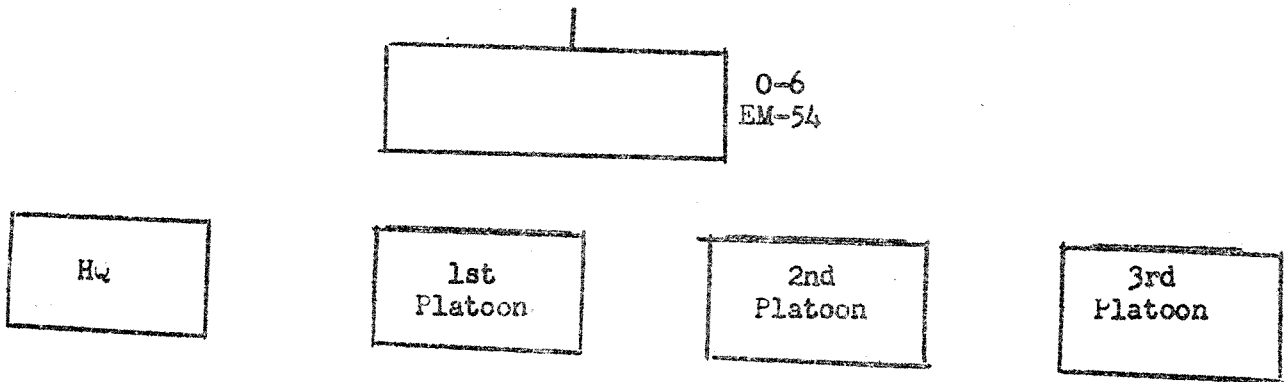

JOB

GRADE

Company Commander.....Captain
 Executive Officer.....1st Lt
 Asst Executive Officer.....2d Lt
 First Sergeant.....Master Sergeant
 Supply Sergeant.....Sergeant First Class
 Armorer.....Corporal
 Company Clerk.....Sergeant
 Asst Company Clerk.....Corporal

Organization of US Army Company



2 106mm RR
 3 Mortars

↑
 Depends on
 size of unit
 whether this plt
 is
present

The Company Headquarters is similar to Cadet HQ except that it contains more personnel such as cooks and drivers, etc.

MAKE NOTATIONS HERE:

Military Organization cont'd

Organization of Battalion

The Cadet B attalion consists of from two to five companies with a small headquarters company.

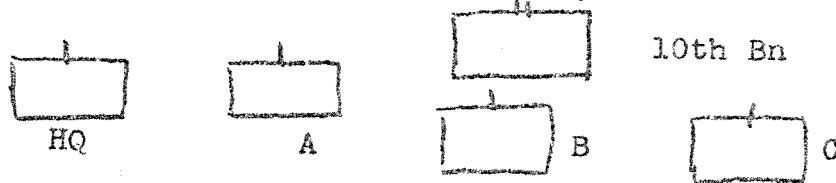

memorize

The HQ Company varies with the strength of the unit. However it may contain:

- a) B attalion Commander - Lt Colonel
- b) Executive Officer - Major
- c) S-1 and Adjutant - Captain
- d) S-2 (Intelligence) - Captain
- e) S-3 (Operations) - Captain
- f) S-4 (Supply) - Captain

- Sergeant Major - MSgt
- Supply Sergeant - SFC
- Operations Sgt - MSgt

- STAFF:
- S-1 Personnel and *Paper work* Administration
 - S-2 Intelligence and Public Relations
 - S-3 Training and Operations
 - S-4 Supply and Logistics *equipment*

The Staff System:

At Battalion level, control and administration becomes so complex that the unit commander needs a group of experts to aid him. This group is called his Staff.

Organization in US Army

In the Pentomic Army the Battalion is now called Battle Group.

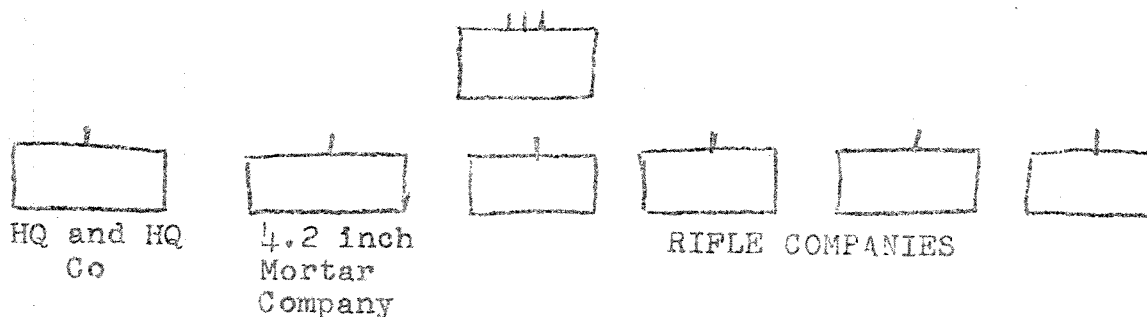

RIFLE PLATOON



1 Off. 4 1/2 Enlisted Men

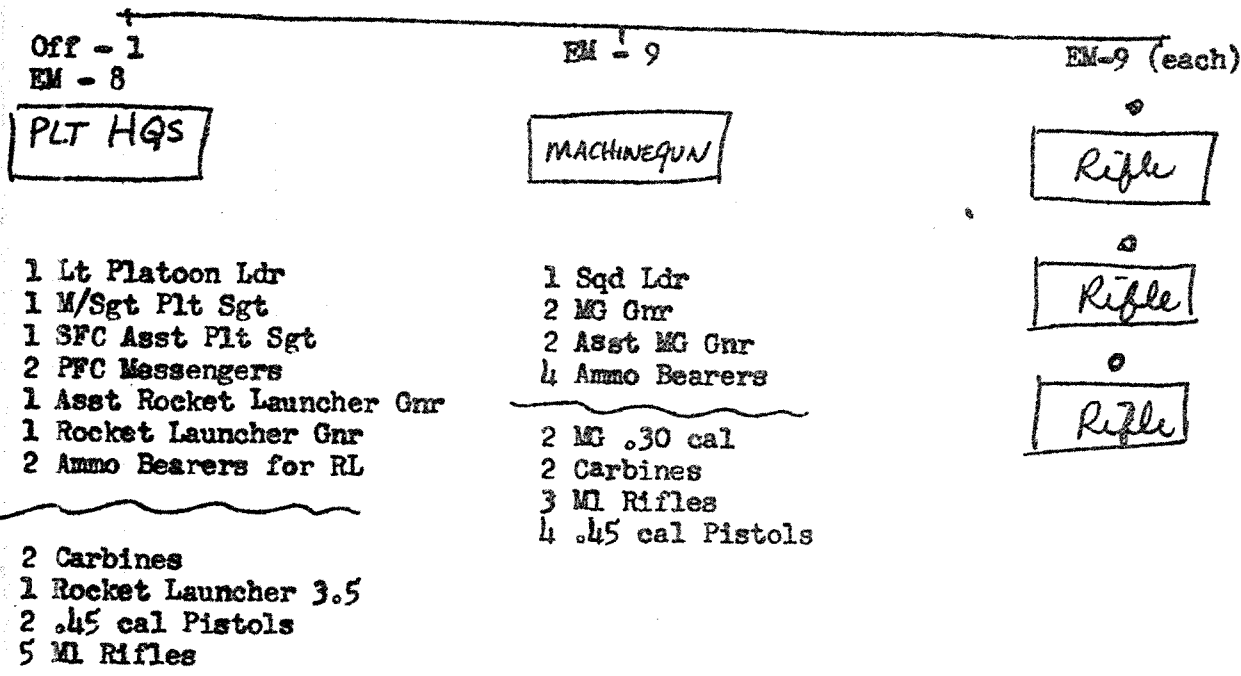

Note: Three Rifle Platoons plus a Weapons Platoon plus a HQs form a Company.

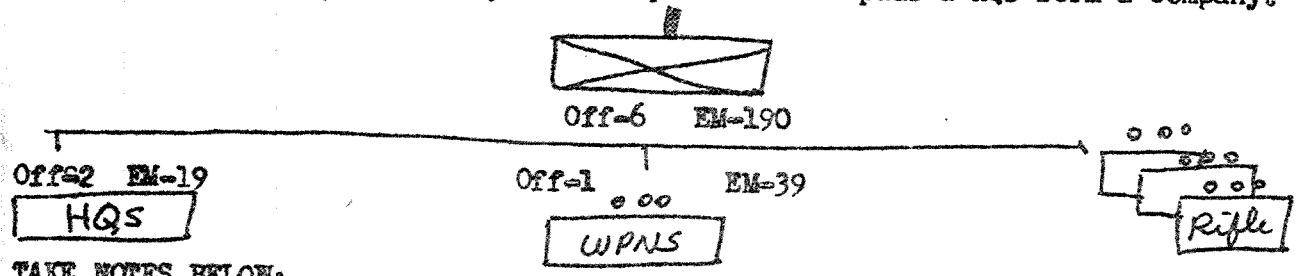

TAKE NOTES BELOW:

WEAPONS PLATOON

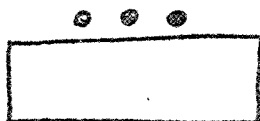

Off-1 EM-39

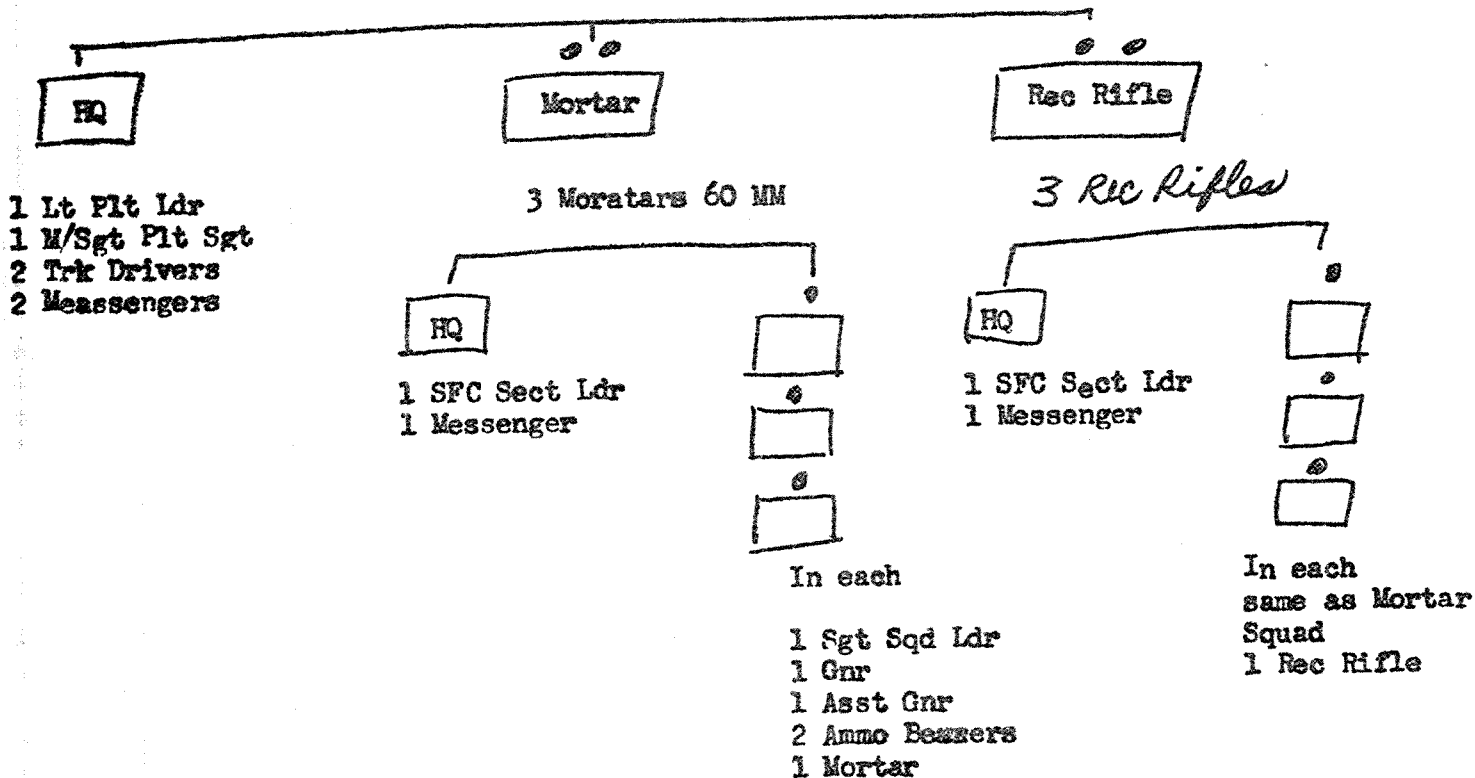

COMPANY HEADQUARTERS

The company headquarters in any company contains the housekeeping support of that company. That is it contains those personnel necessary to feed, clothe, administer, and maintain the company. Thus the HQs has supply, mess, maintenance, and administrative personnel whose normal duties are not fighting. Also you will find Communication personnel among the Co HQs group. Hqs of Rifle Co. contains 19 men.

10th Bn CCC
MILITARY ORGANIZATION
THE COMPANY LEVEL OF ORG

There many types of companys in the army, but we will spend most of our time studying the rifle company since it is the basic unit. However we will take a close look at the artillery battery, the tank company, and the heavy weapons company.

THE RIFLE COMPANY

MISSION: To close with the enemy and capture or distroy him by means of fire and maneuver; or to repel his assault by fire or close combat.

CAPABILITIES: 1. Closing with the enemy and destroying him, using fire and manuver. 2. Repelling enemy assaults by ~~fire~~ fire, close combat, or counterattack. 3. Maneuvering in all types of terrain and climatic conditions. 4. Furnishing a base of fire and maneuver. 5. Siezing and holding ground.

To accomplish the above the company is given 6 officers and 190 men. In addition it is given a variety of weapons such as:

29 Carbines	3 57 MM Recoiless Rifles
6 Light machine guns	30 45 Cal Pistols
1 50 Cal MG	18 Automatic Rifles
3 Rocket launchers	110 M1 Rifles
3 60 MM Mortors	9 Scope Mounted Snipers Rifles

The company also has a variety of equipment such as:

4 Jeeps
1 2 1/2 ton Truck
12 Hand short wave Radios
2 Pack short wave Radios

Now we must see how the men and materials are put together to make a fighting team. First lets look at the rifle squad again

THE RIFLE SQUAD

1 Squad Leader	SFC	Rifle
1 Ast Squad Leader	Sgt	Rifle
2 Automatic Riflemen	PFC	Automatic Rifle
4 Riflemen	PFC	Rifle
1 Sniper	PFC	Rifle with a scope

Remember that ~~two~~ three such rifle squads plus a Machine gun squad and a small headquarters make a platoon. Turn the page and we will look at the platoon in detail.

MILITARY ORGANIZATION

I Organization SQUAD

1. Commanded by a SFC



2. Organization: Sqd Ldr - Rifleman
Asst. Sqd Ldr - Rifleman
Riflemen - three
Sniper - Rifleman with scope
Grenadier - Rifleman with Grenade launcher and Rifle grenades
Barr men - Two (1 is ammo bearer)

II Organization PLATOON

1. Commanded by a 2nd Lt



2. Organization: Command Group
Plt Ldr
Plt Sgt
Plt Guide
Plt Messengers (2)

Three Rifle Squads

One weapons Squad

LMG

3.5 Rocket Launcher

III Organization COMPANY

1. Commanded by a Captain



2. Organization: Command Group
Co. Cmdr
Exec. Off
First Sgt.
Commo. Sgt
Messengers
Radio-Tel. Opr.

Weapons Platoon

Armed with: 1 57mm Rifle
1 60mm Mortar

Three Rifle Platoons

The Rifle Company is the Basic Unit of the Army so this is the unit we will study the most in Cadets.

(Turn page for capabilities of Rifle Company)

RIFLE COMPANY

MISSION: To close with the enemy and capture or destroy him by means of fire and maneuver; or to repel his assault by fire or close combat.

CAPABILITIES:

1. Closing with the enemy and destroying him, with fire and maneuver.
2. Repelling enemy assaults by fire, close combat, or counter attack.
3. Maneuvering in all types of terrain and climatic conditions.
4. Furnishing a base of fire and maneuver.
5. Seizing and holding ground.

To accomplish the above the company is given 6 Officers and 190 men. In addition is given a variety of weapons such as:

29 carbines	3 57mm Recoiless Rifles
6 Light machine guns	30 .45 cal pistols
1 50 cal MG	18 Automatic Rifles
3 Rocket Launchers	110 M1 Rifles
3 60mm Mortars	9 scope mounted Sniper Rifles

The company also has a variety of equipment such as:

4 Jeeps
 1 2½ ton truck
 12 Hand short wave radios
 2 Pack short wave radios

Remember:

Three Rifle Squads; a Command Group and a weapons Sqd make up a Platoon

Three Rifle Platoons; a Company Headquarters and a Weapons Platoon make up a Company.....

THE HEAVY WEAPONS COMPANY

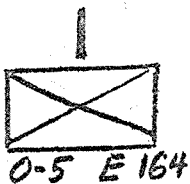

Hq

0-2 E-26

^{0 0 0}
M.G.

0-1 E-39
4 HIMG
4 LIMB

^{0 0 0}
Mort

0-1 E-58
6 81 MM
Mortar

^{0 0 0}
A.T.

0-1 E-41
6 105 MM
R RIFLE

MILITARY ORGANIZATION

I Organization:

A. Organization - Squad through Regiment

1. Rifle Squad: (Commanded by a SFC )

Sqd Ldr - Rifleman 1
 Asst. Sqd Ldr - Rifleman 1
 Riflemen - 5 (1 Sniper, 1 Grenadier)
 BAR men -2

GOLD

2. Rifle Platoon: (Commanded by a 2nd Lt. )

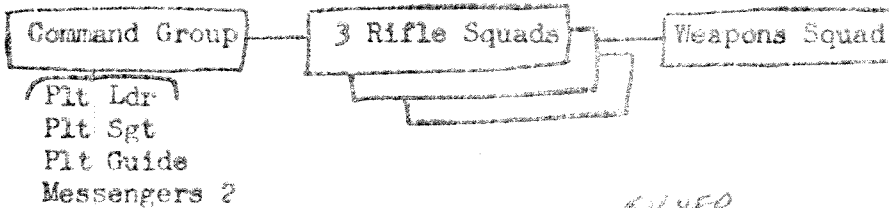

SILVER

3. Rifle Company (Commanded by a Capt. )

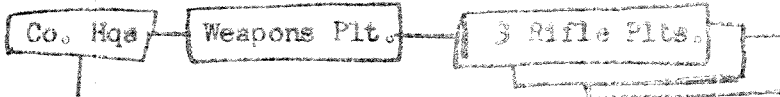

Co. Cm'r.
 Exec. Off.
 1st Spt
 Commo. Sgt
 Messengers
 Radio-Tel. Opr.

1 57mm Rifle
 1 60mm Mortar

All weapons previously listed.

SILVER

4. Battalion (Commanded by a Lt. Colonel )

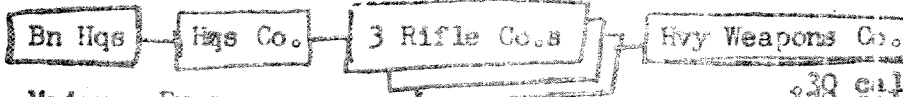

Major - Exec.

30 cal Light MG
 130 cal Hvy MG
 .50 cal. MG
 81mm Mortar
 75mm Rifle
 Rocket Launchers
 Rifles, Carbines, Pistols



5. Regiment: (Commanded by a Full Colonel )

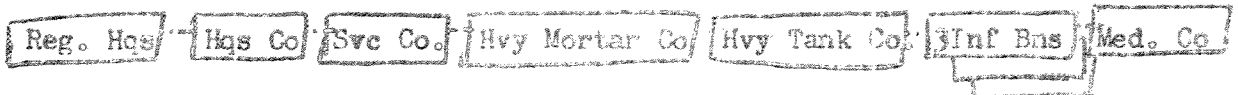

Has Staff same as Bn (All have assistants)

- 1) Hqs Co: Establishes, Operates, Defends Reg. Hqs.
- 2) Svc. Co.: Furnishes clerical staff for Reg Hqs and handles transportation
- 3) Hvy Mortar Co: Provides fire support (4 2 mortars) and supply.
- 4) Hvy Tank Co: Support fire and defense against tanks.
- 5) Medical Co: Medical treatment for members of Reg.

Reg. also has Artillery support from a Battery (2 to 6 pieces)

10th Bn CCC

MILITARY ORGANIZATION
THE DIVISION

The division is the smallest unit of combined arms (Infantry, Artillery, and armor with the strength, administration, and supply support necessary to fight independently in sustained combat. The United States Army has three types of divisions, the infantry, the airborne, and the armored. The infantry and the airborne are similar except the airborne XX division is capable of being dropped by parachute less it tank units. The armored division however is quite different.

Here is the infantry division.

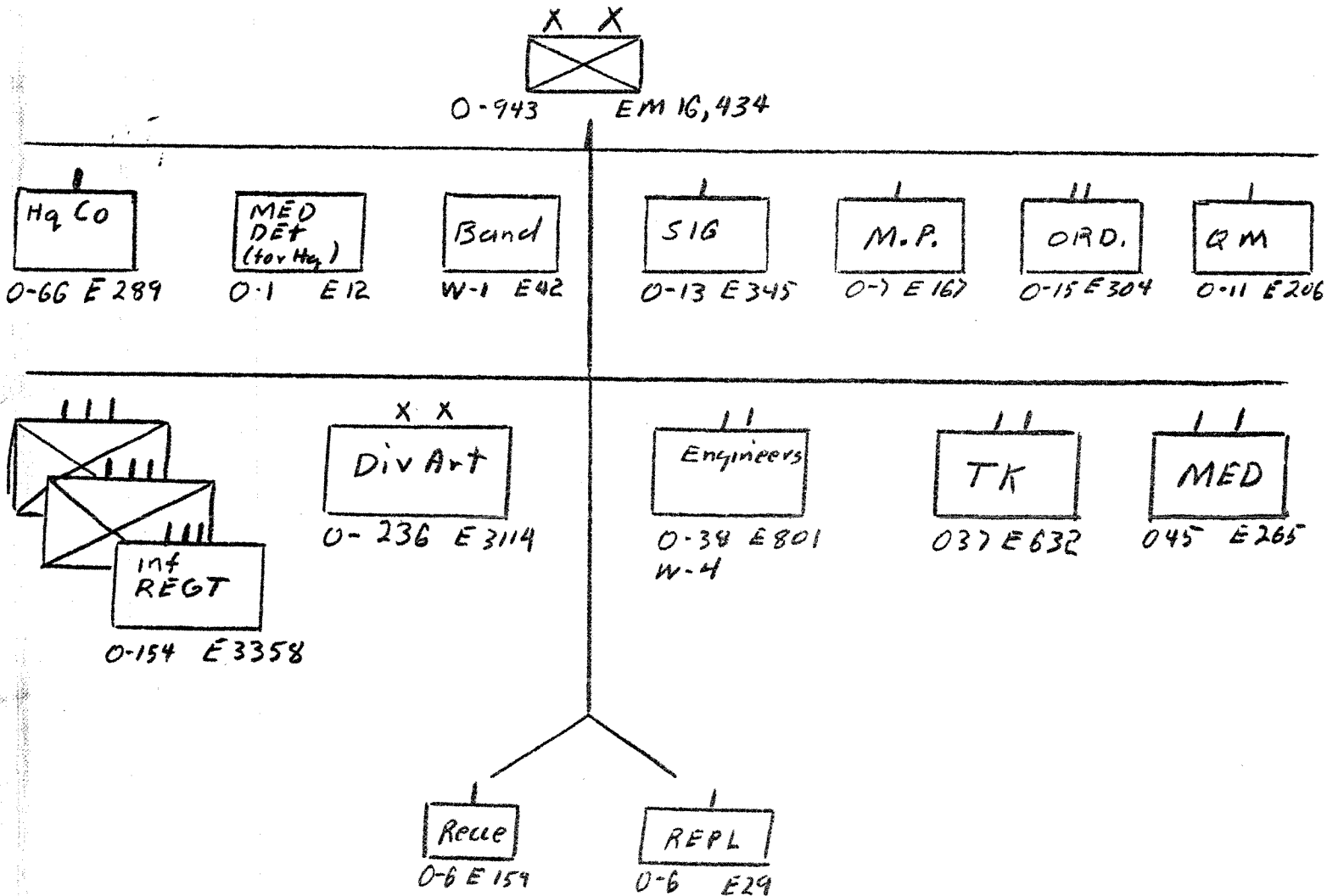

Aircraft - 16
Helicopter 10
Tanks 147
Radios 1606
Telephones 1260

Carbines 5292
M1 Rifle 8047
BAR 493
105MM HOW 54
155MM HOW 18
Twin 40MM AA 32
MG's 30 cal 345
MG's 50 cal 356

105MM R. Rifle 57
57MM R. Rifle 81
Pistol 45 cal 2270
Rocket launcher 550
60MM Mortar 81
81MM Mortar 54
4.2In Mortar 36

THEATER COMMANDER-ONE AREA

ARMY GROUP

GROUP

XXXXX

SIXTH

XXXXX

SIXTH

FIELD ARMY

XXXX

I

XXXX

I

CORPS

XX



XX



DIVISION



REGIMENT



BATTALION



RIFLE COMPANIES

















RIFLE COMPANY



RIFLE PLATOON

MILITARY ORGANIZATION

I Military Organizational symbols:

- | | |
|---|--|
| <p>1.  Company Commander</p> <p>2.  Executive Officer</p> <p>3.  Platoon Leader</p> <p>4.  First Sergeant</p> <p>5.  Platoon Sergeant or Sergeant Major</p> <p>6.  Platoon Guide</p> <p>7.  Squad Leader</p> <p>8.  Assistant Squad Leader</p> | <p>9.  Rifleman</p> <p>10.  Guidon Bearer</p> <p>11.  Colors</p> <p>12.  Squad</p> <p>13.  Section</p> <p>14.  Platoon</p> <p>15.  Company</p> |
|---|--|

II Organization of Rifle Squad: * A squad is the smallest organized group in the Army.

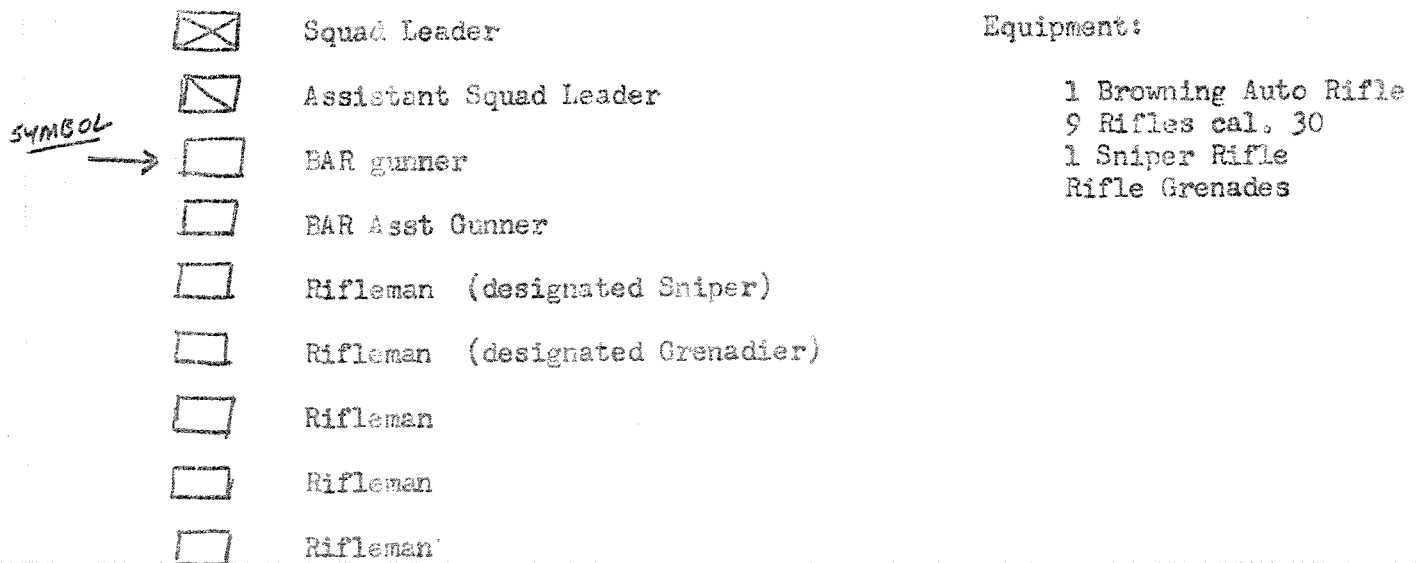

Mission of Rifle Squad: Close with the enemy and destroy him.

Operations: In the attack - Squad operates as unit with other squads of the

Organization: cont'd

DeFense - the squad is assigned a sector to cover with fire
the squad leader assigns the individual rifleman their area with ~~in~~ in this
III Organization of Weapons Squad: Equipment: sector

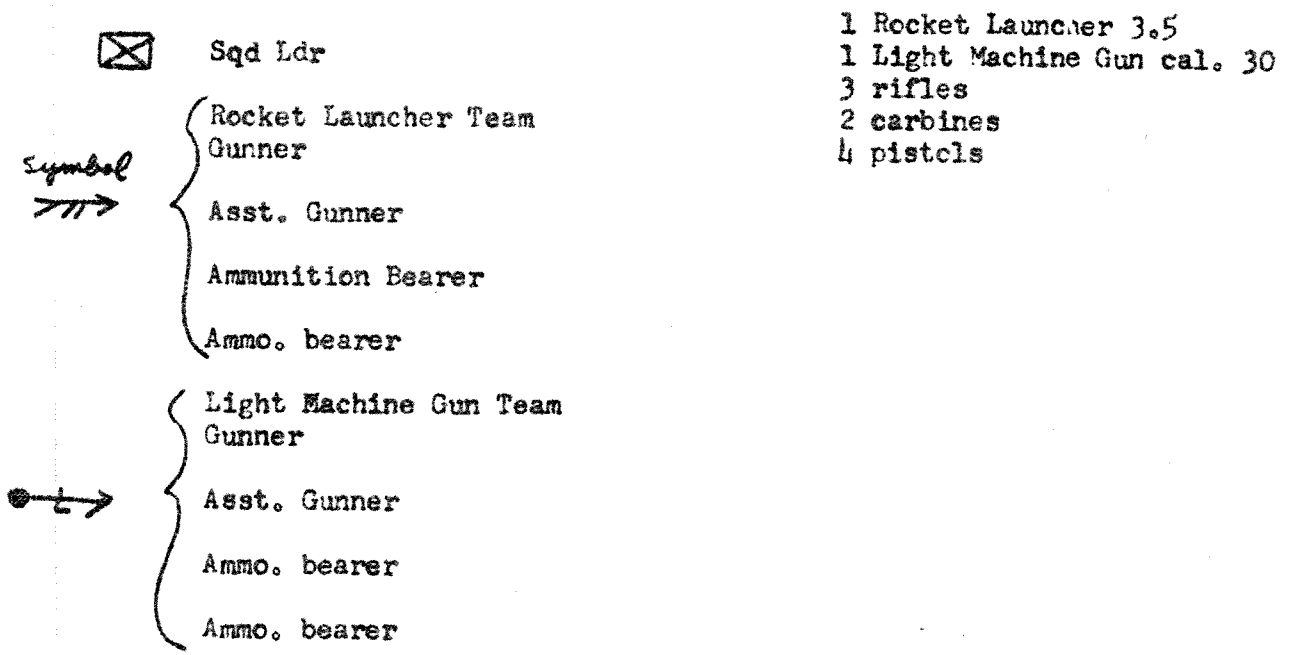

* Mission: Support of Rifle Squads in Platoon.

NOTES:

In the rifle platoon there are 3 rifle squads and one weapons squad.

Military Organization

The Company Level

The basic unit of the US Army is the Rifle Company.

THE RIFLE COMPANY

Mission: To close with the enemy and capture or destroy him by means of fire and maneuver; or to repel his assault by fire or close combat.

Capabilities:

- 1) Closing with the enemy and destroying him using fire and maneuver.
- 2) Repelling enemy assaults by fire, close combat, or counter attack.
- 3) Maneuvering in all types of terrain and climatic conditions.
- 4) Furnishing a base of fire and maneuver.
- 5) Seizing and holding ground.

To accomplish the above the Company is given 6 Officers and 190 men. In addition it is given a variety of weapons, such as:

29 Carbines	3 57 MM Recoiless Rifles
6 Light Machine Guns	30 .45 cal Pistols
1 50 cal MG	18 Automatic Rifles
3 Rocket Launchers	110 M1 Rifles
3 60 MM Mortars	9 Scope mounted Sniper Rifles

Plus the following equipment:

- 4 Jeeps
- 1 Two & 1/2 ton Truck
- 12 Hand short wave radios
- 2 Pack short wave radios

In order to see how the men and materials are put together to make a fighting team we must first look at a Rifle Squad:

<u>Men</u>	<u>Grade:</u>	<u>Wpn:</u>
1 Squad Leader	SFC	Rifle
1 Asst Sqd Ldr	Sgt	Rifle
2 Auto Riflemen	PFC	Browning Auto Rifles
4 Riflemen	PFC	M1 Rifle (One designated as Grenadier)
1 Sniper	PFC	Rifle with Scope

* Note: Three such rifle squads plus a weapons squad and a small headquarters make a Platoon.

TAKE NOTES BELOW:

ORGANIZATION OF THE ARMY

COMPANY LEVEL:

The Rifle Company is the Basic Unit of the Army so this is the unit we will study.

THE RIFLE COMPANY

MISSION: To close with the enemy and capture or destroy him by means of fire and maneuver; or to repel his assault by fire or close combat.

CAPABILITIES: 1. Closing with the enemy and destroying him, using fire and maneuver.
2. Repelling enemy assaults by fire, close combat, or counter attack.
3. Maneuvering in all types of terrain and climatic conditions.
4. Furnishing a base of fire and maneuver.
5. Seizing and holding ground.

To accomplish the above the company is given 6 Officers and 190 men. In addition it is given a variety of weapons such as:

29 Carbines	3 57 MM Recoilless Rifles
6 Light machine guns	30 .45 Cal Pistols
1 50 cal MG	18 Automatic Rifles
3 Rocket Launchers	110 M1 Rifles
3 60 MM Mortars	9 Scope mounted Snipers Rifles

The company also has a variety of equipment such as:

- 4 Jeeps
- 1 2½ ton truck
- 12 Hand short wave radios
- 2 Pack short wave radios

Now we must see how the men and materials are put together to make a fighting team. First lets look at the Rifle Squad again:

THE RIFLE SQUAD

1 Sqd Ldr	SFC	Rifle
1 Asst Sqd Ldr	Sgt	Rifle
2 AR men	PFC	Automatic Rifle
4 Riflemen	PFC	Rifle
1 Sniper	PFC	Rifel with scope

Remember that three such rifle squads plus a machine gun squad and a small headquarters make a platoon. Turn the page for a look at the platoon.

THE WEAPONS PLATOON

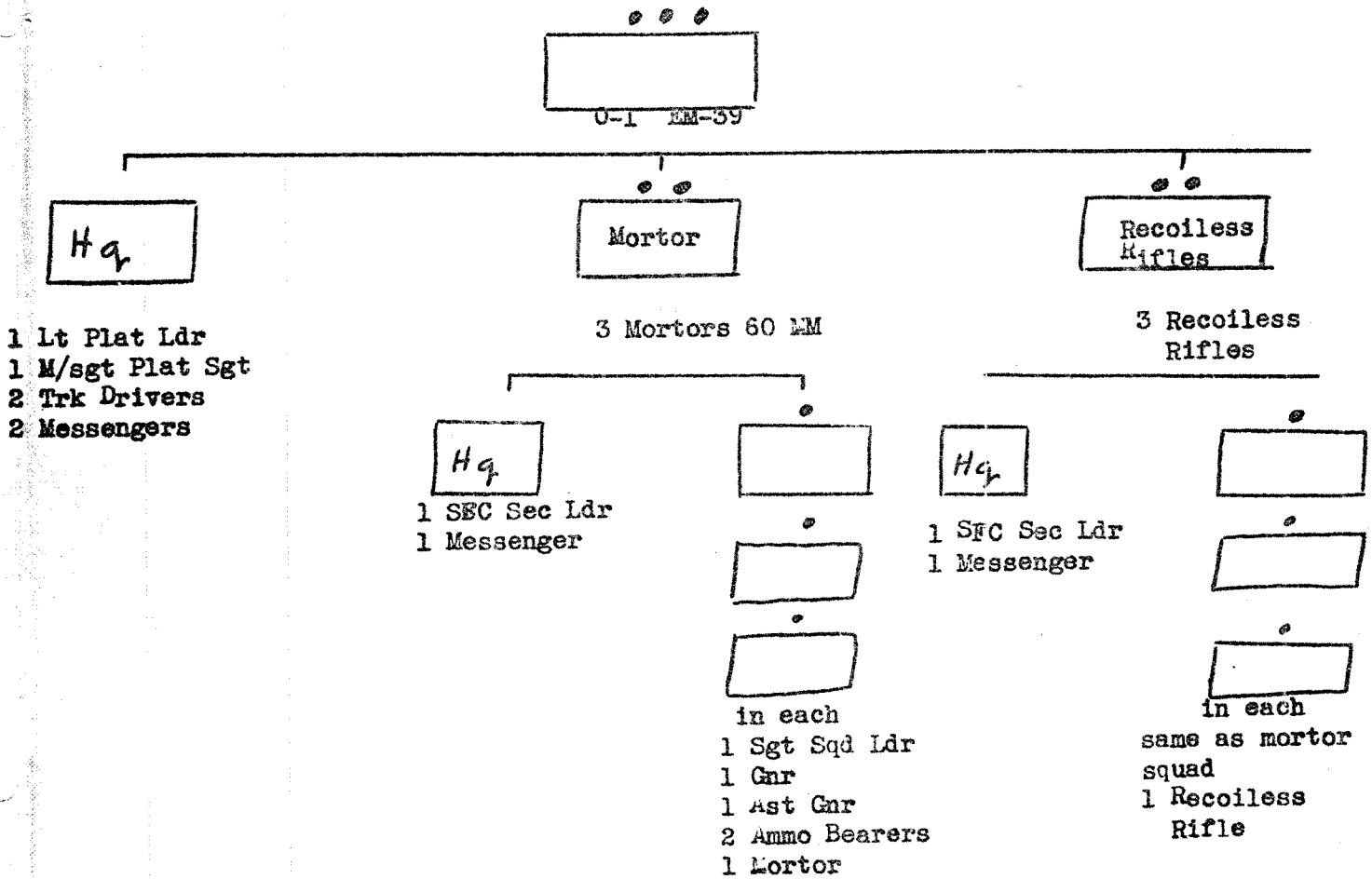

Company Headquarters

The company headquarters in any company contain the housekeeping support of that company. That is it contains those personnel necessary to feed, clothe, administer, and maintain the company. Thus the headquarters has supply, mess, maintenance, and administrative personnel whose normal duties are not fighting. Oh yes and the company Hq also has communication personnel. The company headquarters of an a rifle company contains 19 men.

Now let's turn the page and look at some of the other combat companies.

THE RIFLE PLATOON

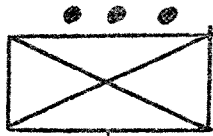

O-1 EM-190 44

O-1
EM-8

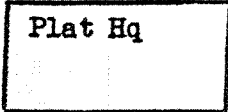

- 1 Lt Plat Ldr
- 1 M/Sgt Plat Sgt
- 1 Sgt 1st Cl Ast Plat Sgt
- 2 PFC Messengers
- 1 Rocket Gnr
- 1 Ast Rocket Gnr
- 2 Ammo Bearer

- 2 Carbines
- 1 Rocket Launcher
- 2 Pistols
- 5 Rifles

EM-9

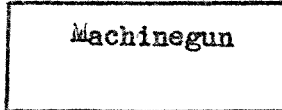

- 1 Sqd Ldr
- 2 MG Gnr
- 2 Ast MG Gnr
- 4 Ammo Bearers

- 66
- 2 Machine guns
- 2 Carbines
- 3 Rifles
- 4 Pistols

EM-9 (ea)

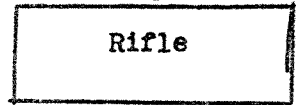

Three rifle platoons plus a weapons platoon plus a headquarters form a company. Here is how the whole company looks.

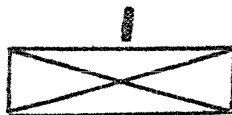

O-6 EM-190

O-2 EM-19



O-1 EM-39



Turn the page and we will take a look at the headquarters and the weapons platoon

CADETS

I. How the cadet corp is organized

II. Company officers - NCOs

III. Promotions or demotions

A. Performance

B. Test for every promotion - at the end of the first semester.

C. efficiency

D. State requirements

I. Organization of the 10th Bn.

A. The Commandant is responsible to the principal who is responsible to the state

II. Grading System

A. Uniform day usually Tuesday on each wk.

1. 100% - 1 miss, bring a note from home.

(1.) must make up.

((1.)) F if you fail

((2.)) Uniform day $\frac{1}{3}$ of grade

((3.)) tests $\frac{1}{3}$ of grade

((4.)) Conduct and drill $\frac{1}{3}$ of grade

A. - 3 pts

B. - 2 pts

C. - 1 pts

D. - 0 pts

F. - -1 pt.

III. Uniform

IV. Organization of Company
1st platoon

B. Company Headquarters

Company Commander

Executive officer

Ass. Executive officer

1st Sargeant

Company Clerks

Supply Crew

platoon leader

1st platoon

platoon sargeant

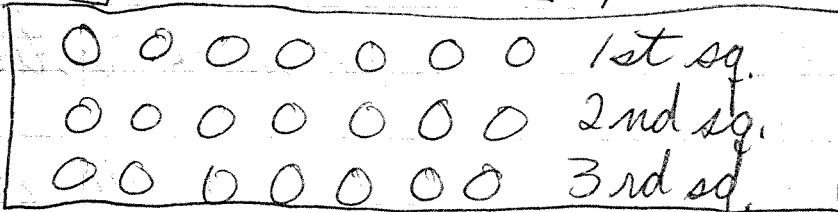

V. Proficiency Badges

A. Basic 1 yr.

B. Intermediate 2 yrs.

C. Advanced 3 and 4 yrs.

VI. Awards

A. Community service

I. Everybody in the Company

- | | |
|----------------------|-------------------------|
| A. 2nd Lt. Andrews | Co. Cdr. |
| B. 2nd Lt. Herron | Exec. off. |
| C. 2nd Lt. Simone | Exec. Asst. supply off. |
| D. 2nd Lt. Smilanick | 1st platoon leader |
| E. 2nd Lt. Cooper | 2nd platoon leader |
| F. 2nd Lt. Hice | 3rd platoon leader |
| G. C.F.C. Bean | Co. Clk. |
| H. Cadet Love | Co. Clk. |
| I. Corporal Igarashi | Co. Clk. |

II. Supply Crew

- | | |
|----------------------|--------------|
| A. Corporal Barber | Supply Clerk |
| B. Corporal Williams | Supply Clerk |
| C. Cadet Merandos | Supply Clerk |

III. 1st Platoon

- | | |
|-------------------|--------------|
| A. Sgt. Brown | Platoon Sgt. |
| B. 1st sq. leader | Carrmona |
| C. 2nd sq. leader | Roman |
| D. 3rd sq. leader | Weigh |

IV. Military Courtesy











A. Salute

1. When in doubt salute
- B. salute only officers or N.C. acting in the position of officers
- C. In Uniform salute all officers of the armed forces.

D. In Cadets salute all officers in Uniform or not during class period

1. Salute 6 paces from an officer on the street or in school
(1.) never left hand

II. Cadet Insignias

- A.  Gold disc on collar - 2nd Lt.
- B.  Silver disc on collar - 1st Lt.
- C.  Silver disc on collar - Capt.
- D.  Cadet First Class
- E.  Cadet Corporal
- F.  plain Sargeant
- G.  Sargeant 1st Class
- H.  master Sargeant
- ~~I. ~~
- I.  1st Sargeant

Military Organization

- I. A co-ordinated action is based on:
 - A. one leader
 - B. his followers
 - C. an argued course of action
- II. Individual squad members
 - A. we must have an organized idea by the squad leader.
 1. Squad leader equips, disciplines, and looks out for the welfare of his men.
 2. BAR man fires the BAR (primary) but if it breaks down he uses a 30 caliber weapon.
 3. assistant squad leader covers, protects, and brings up the rear of the squad.
 4. assistant BAR man carries ammo and a 30 caliber weapon.
 5. specialists
 - a. sniper to go and infiltrate. He uses a sniper scope
 - b. grenadier launches grenades by using a rifle.