

# WEAPONS

AUTOMATIC PISTOL , CALIBER .45  
ML911A1

X

Basic Information:

1. Recoil operated
2. Magazine fed
3. Self-loading
4. Semi-automatic
5. Weight 2.4 lbs empty - 2.9 lbs fully loaded
6. .45 caliber ammunition
7. Magazine capacity 1 to 7 rounds
8. Dexterity of pistolman determines rate of fire
9. Has four safety devices:
  - a) Safety lock
  - b) Grip safety
  - c) Half-cock safety
  - d) Muzzle disconnecter safety

Nomenclature:

- |                       |                                  |
|-----------------------|----------------------------------|
| 1. Barrel bushing     | 11. Magazine clip release button |
| 2. Recoil spring plug | 12. Trigger guard                |
| 3. Muzzle             | 13. Trigger                      |
| 4. Front sight        | 14. Slide stop                   |
| 5. Slide              | 15. Receiver assembly            |
| 6. Rear sight         |                                  |
| 7. Hammer             |                                  |
| 8. Safety lock        |                                  |
| 9. Grip safety        |                                  |
| 10. Magazine          |                                  |

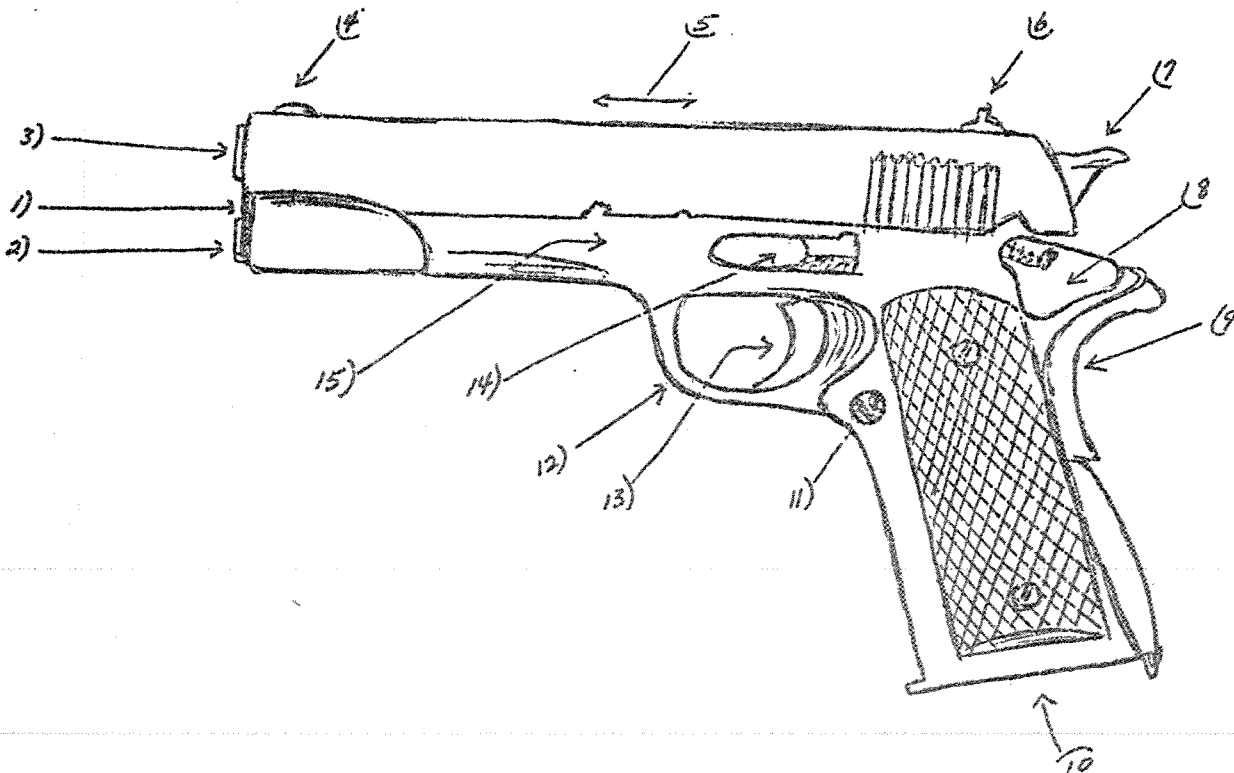

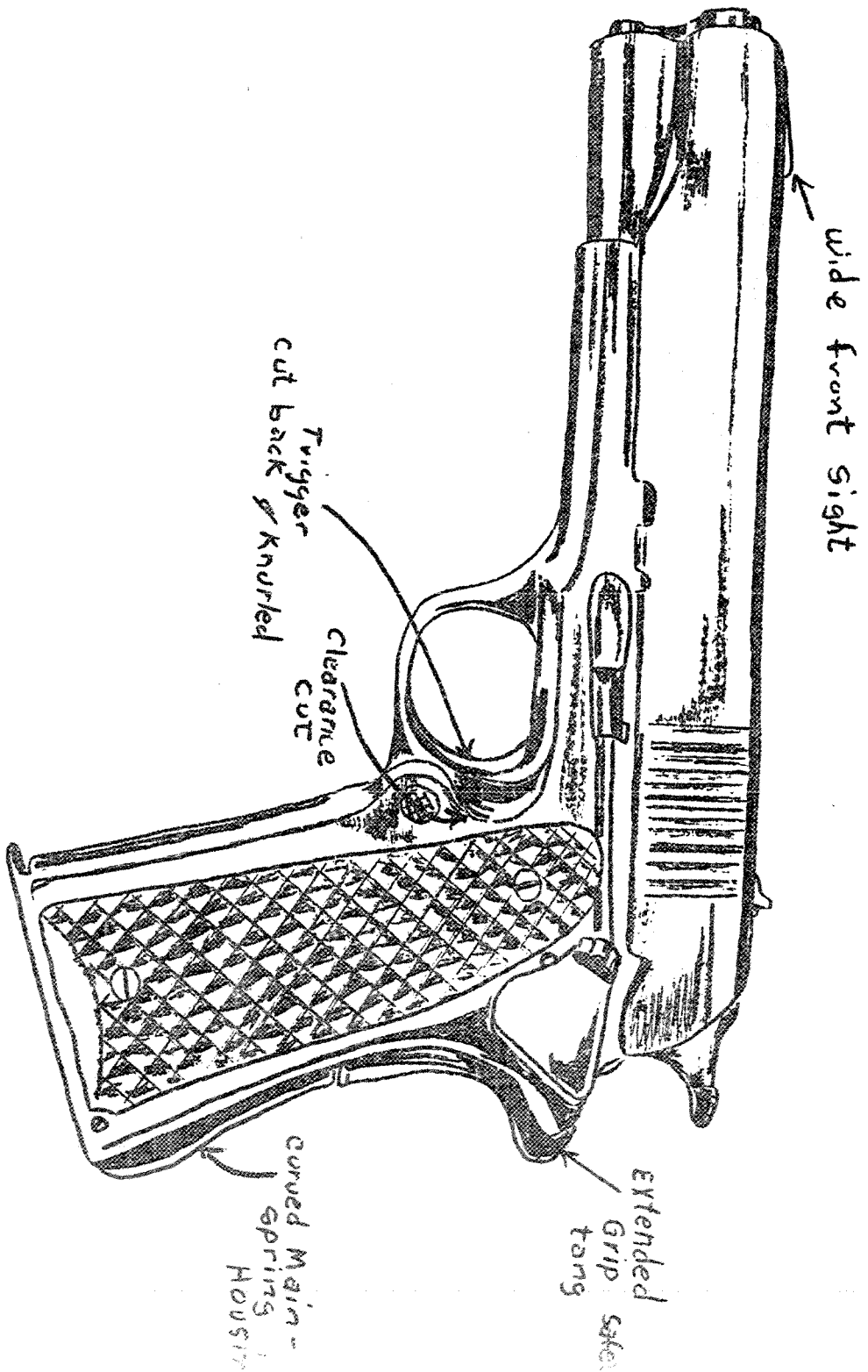

Cal. 45  
M 1911A1

U.S. .45 1911 & 1911A1 AUTOMATIC PISTOL

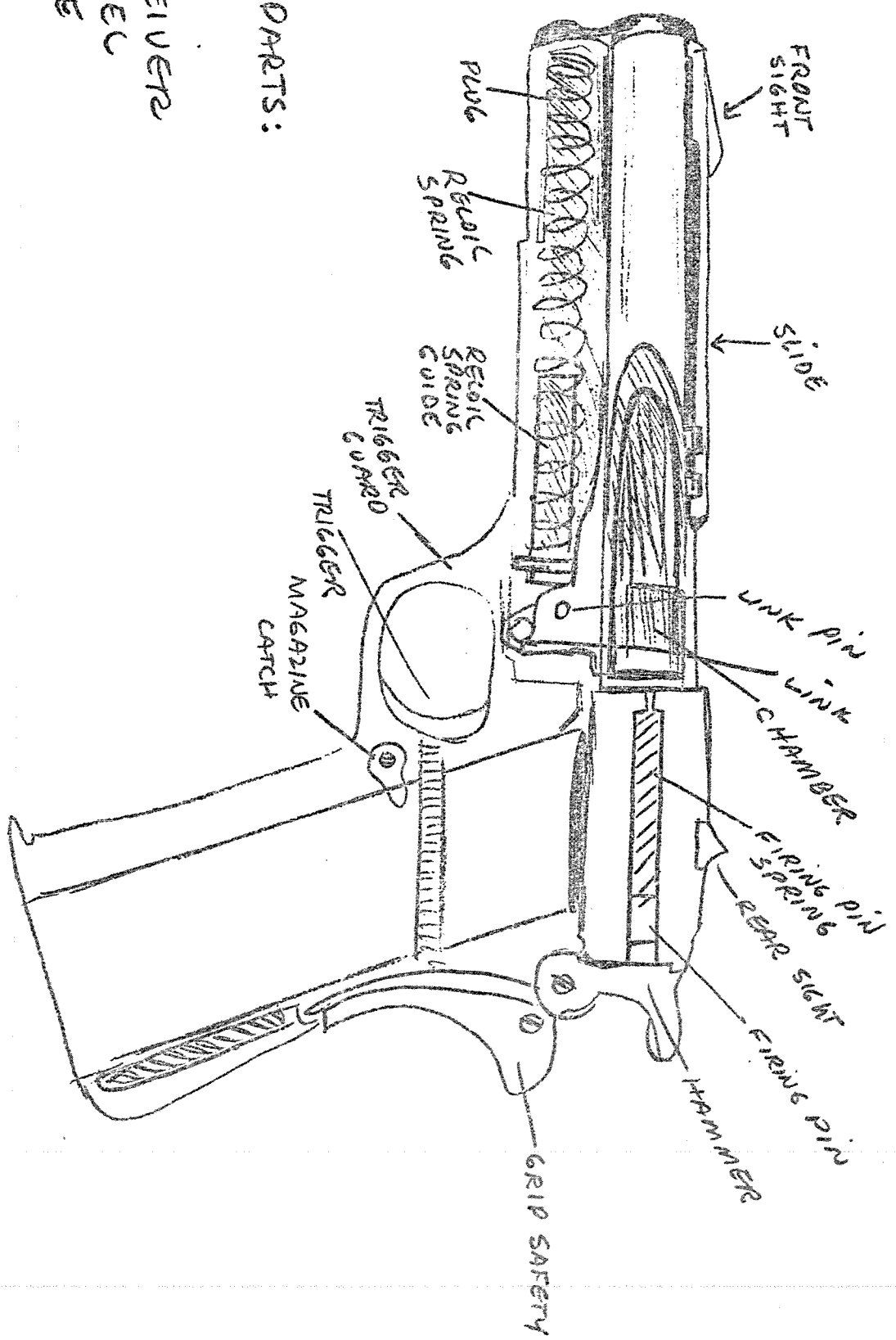

3 MAIN PARTS:

RECEIVER  
 BARREL  
 SLIDE

+

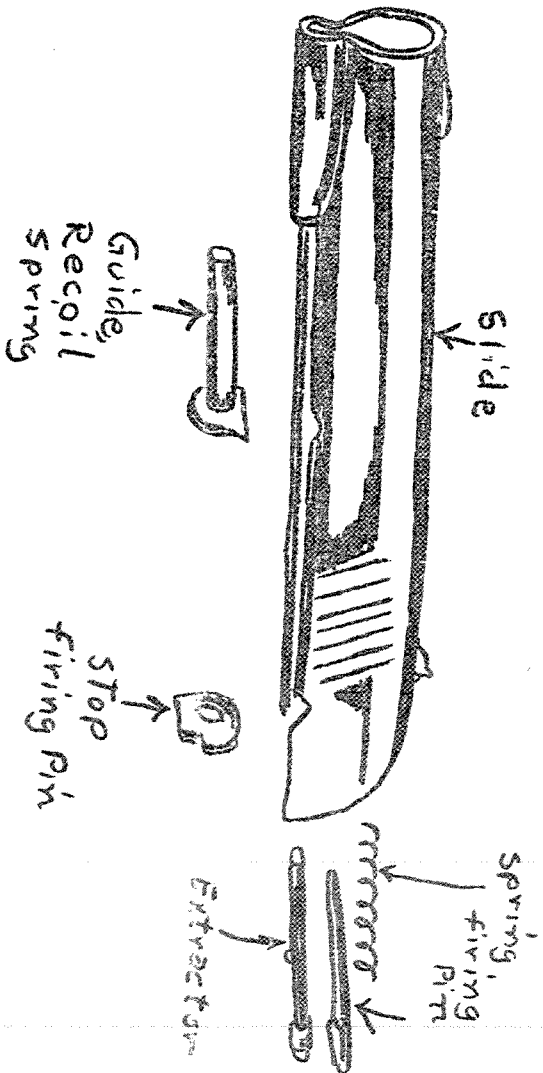
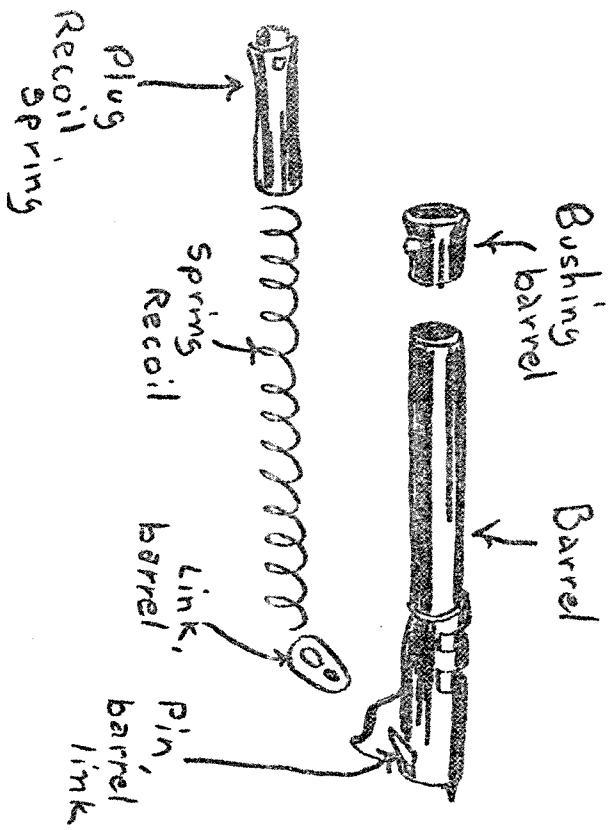

slide groupe  
M 1911 A1

4

# M-1903 U.S. CALIBER .30 06

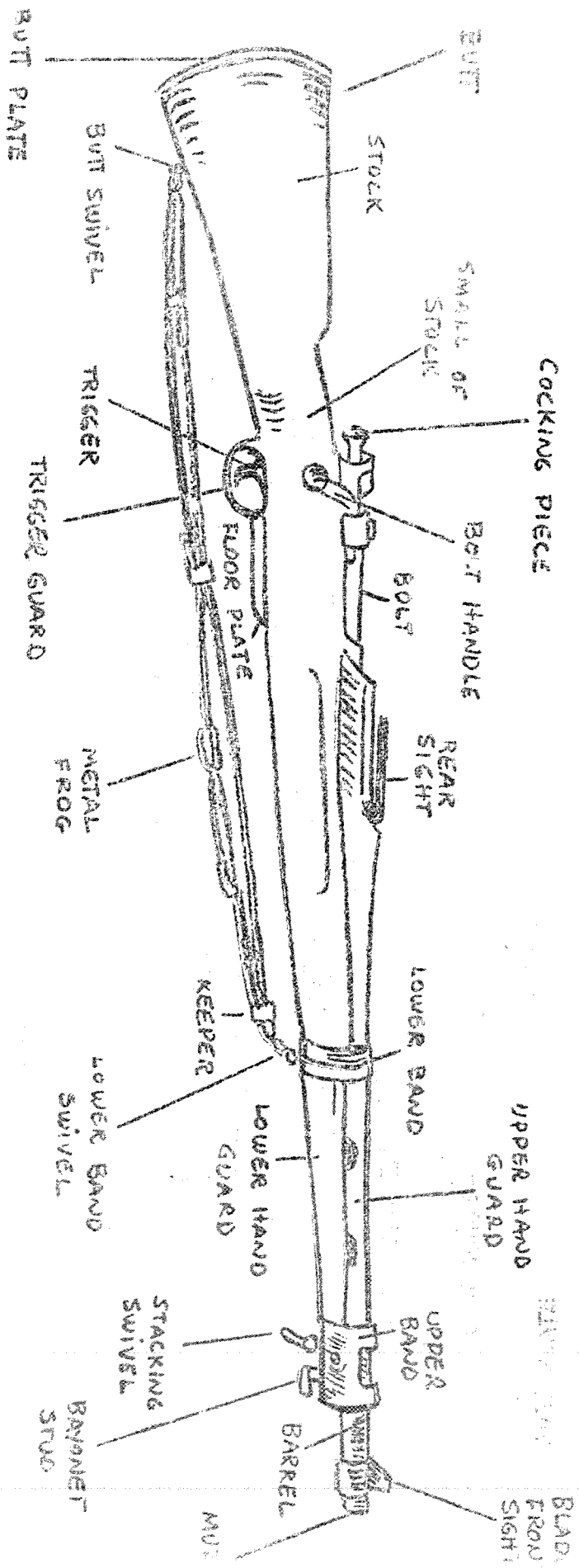

NO 08. 2381740 S.N

3061-W

# Bipod Assembly M 1919 A6

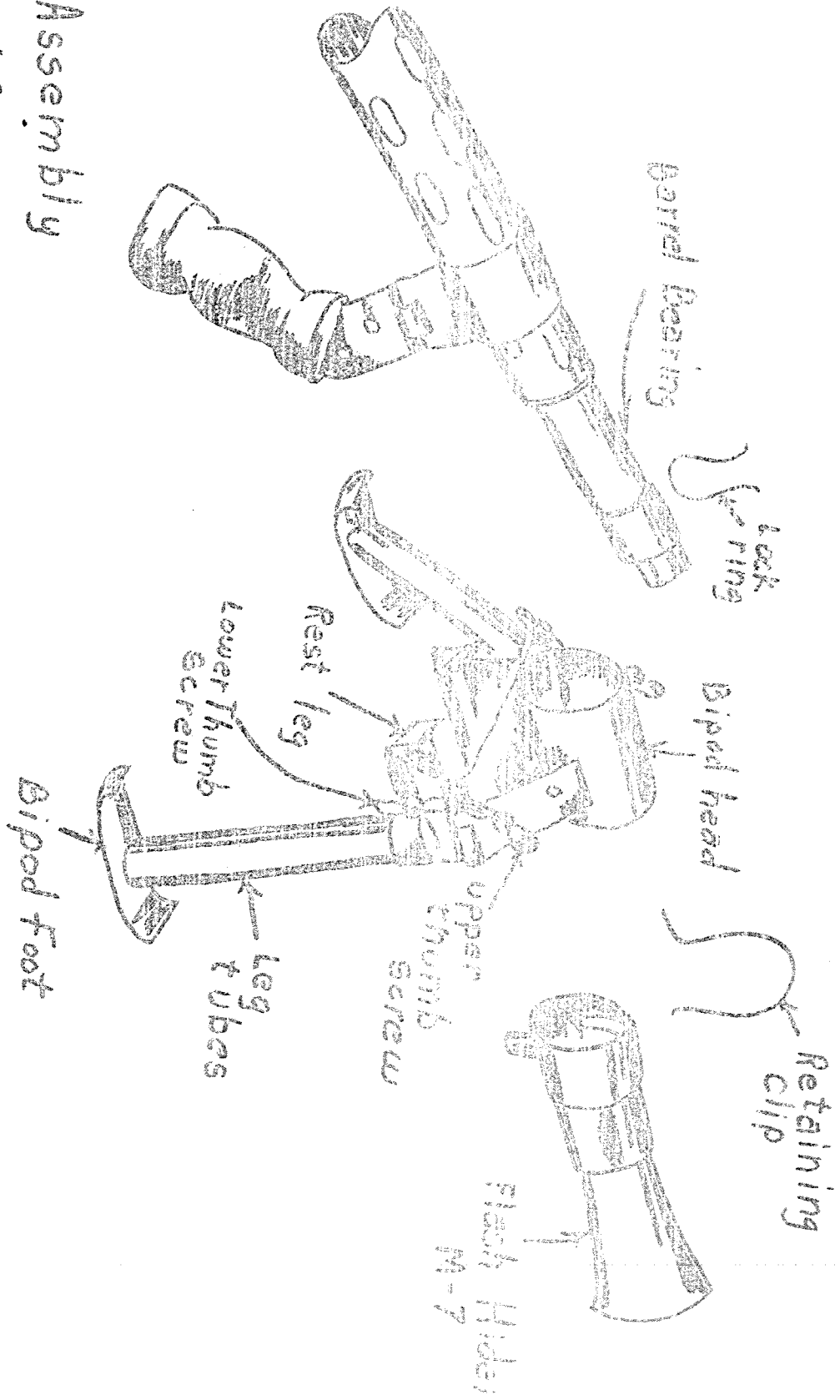

Nomenclature:

- 1. Butt Plate
- 2. Heel & Toe of Stock
- 3. Butt of Stock
- 4. Small of Stock
- 5. Rear sight with adjusting knobs
- 6. Safety lever
- 7. Bolt handle
- 8. Bolt
- 9. Breech and Chamber
- 10. Barrel
- 11. Front sight (covered)
- 12. Muzzle
- 13. Upper swivel
- 14. Sling
- 15. Magazine
- 16. Trigger guard
- 17. Trigger
- 18. Lower swivel

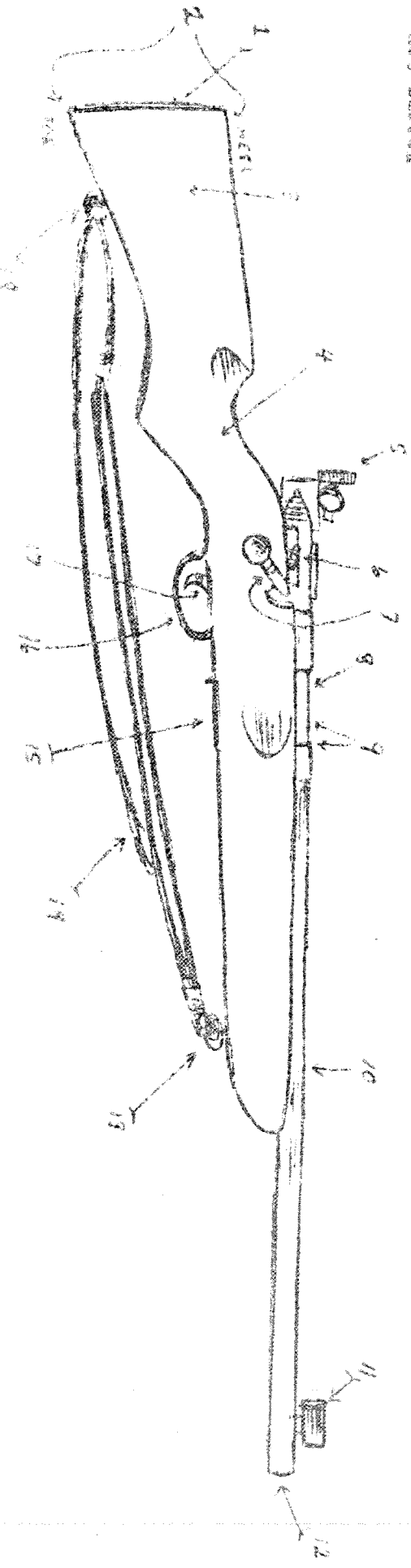

This weapon has the following important features:

- A. Ammo. - Rimfire .22 cal Long Rifle
- B. Has calibrated rear sight with windage and elevation adjustment
- C. Has interchangeable front sight with cover
- D. Color coded safety lever
- E. Has a rear peep sight
- F. Excellent accuracy at 50 Yds

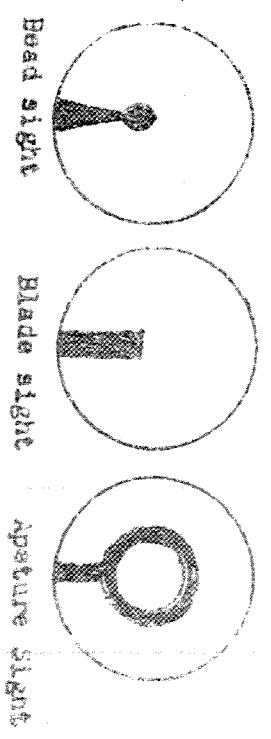



x

# Stock Assembly M-1919 A6

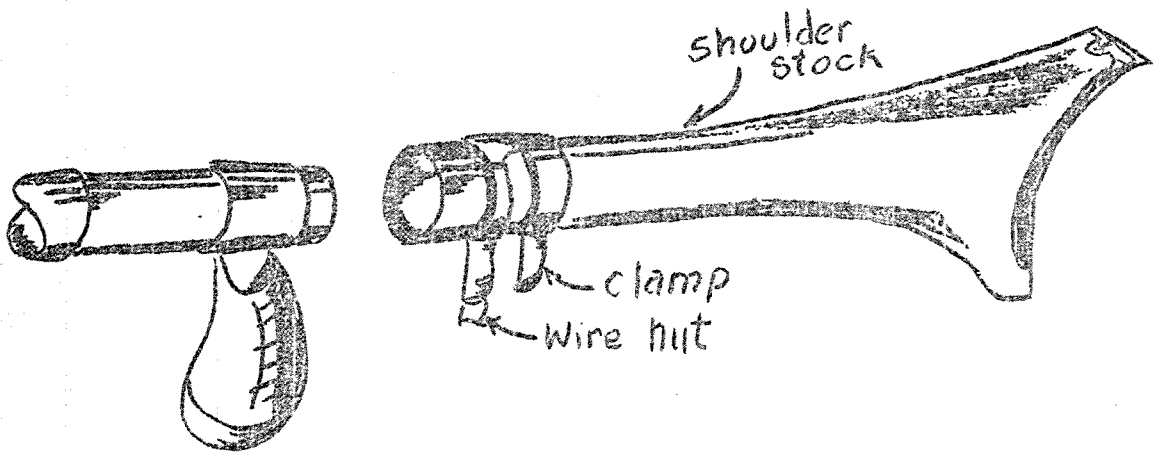

Cal. .30  
M 37 (tank)

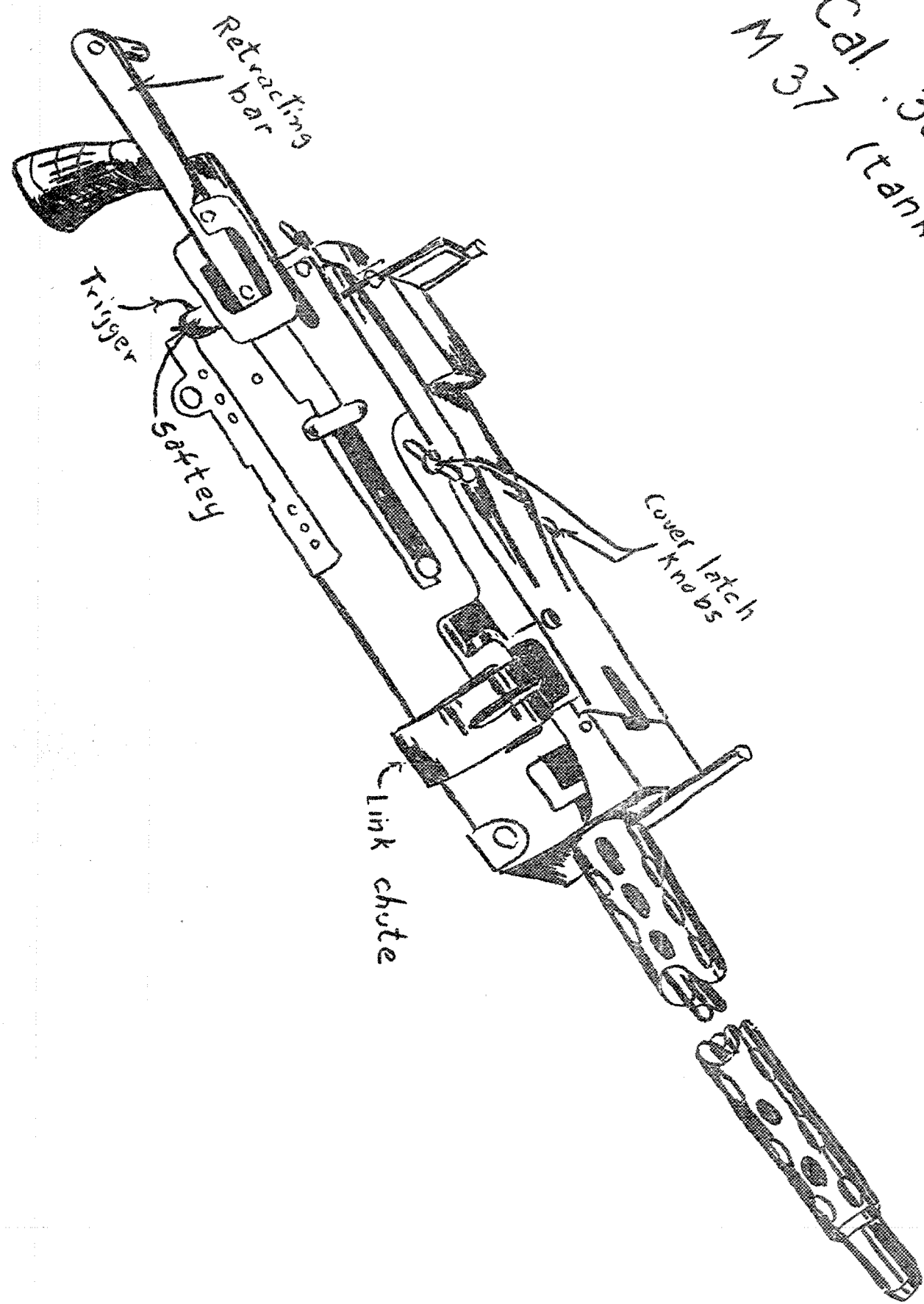

X

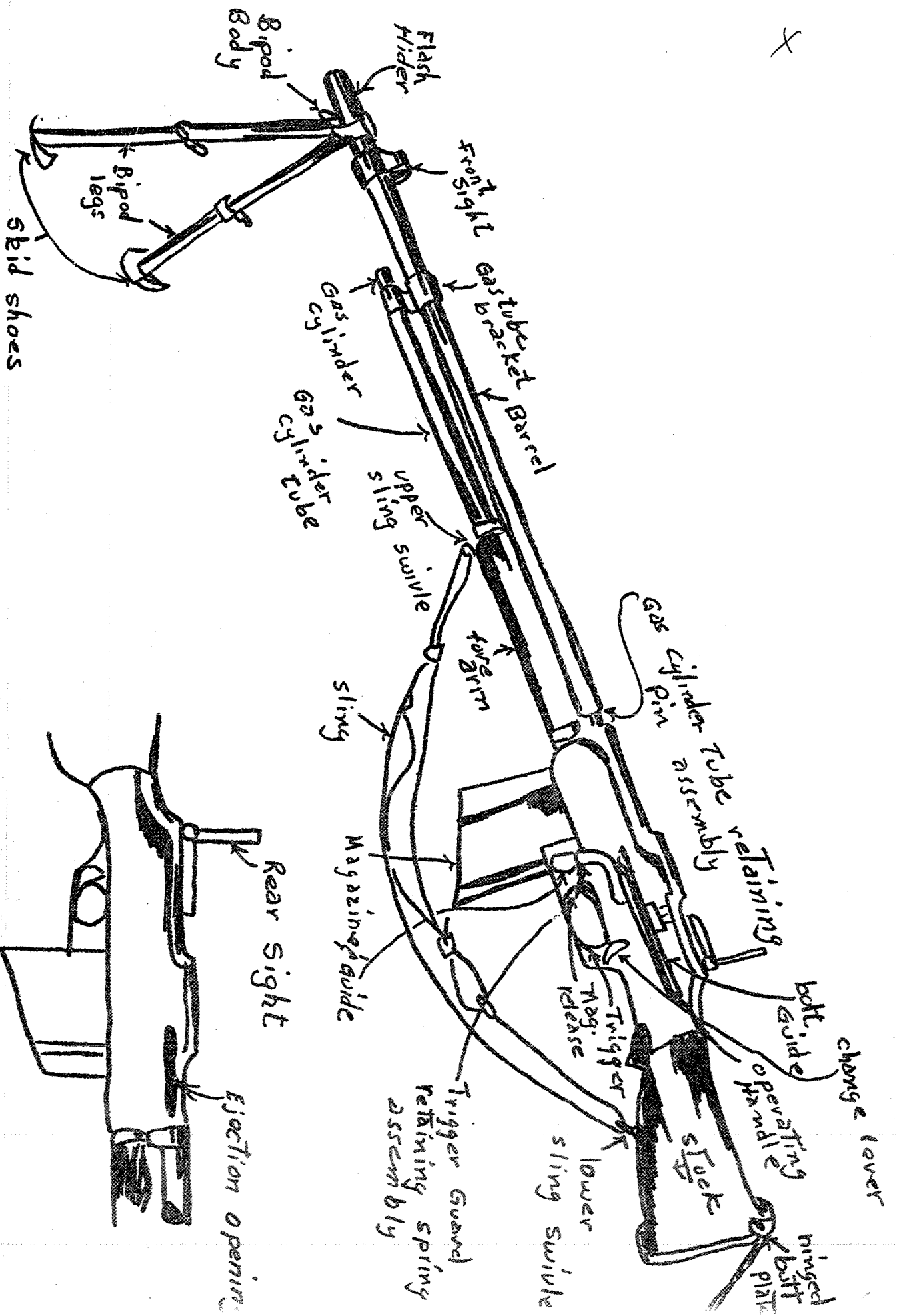

Browning Automatic Rifle Calib. .30, M1918 A2

# BROWNING AUTOMATIC RIFLE CALIBER .30

## Description:

1. Air cooled
2. Gas operated
3. Magazine fed
4. Shoulder weapon mounting a bipod
5. Caliber .30
6. Magazine capacity- 20 rounds

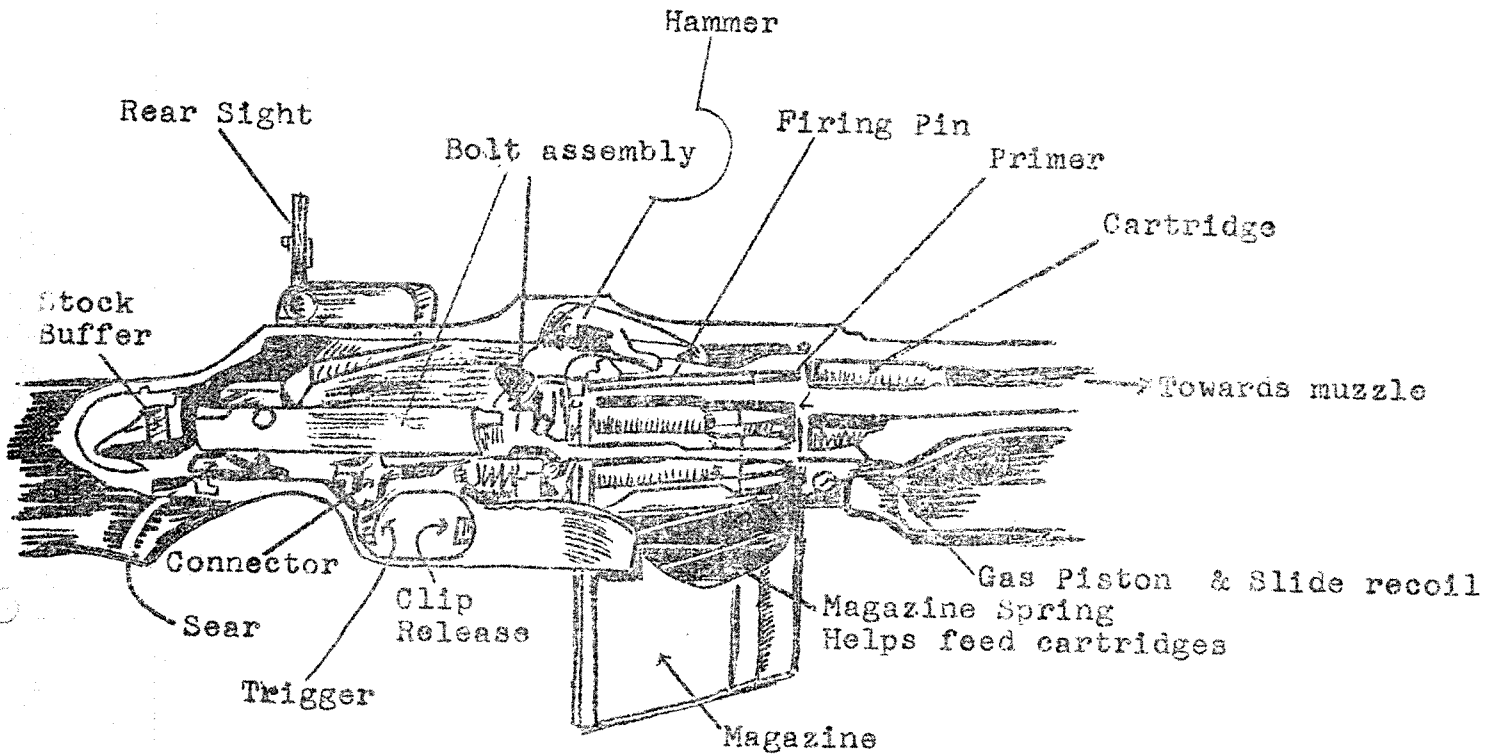

7. Magazine weight - full 1 lb. 7 ounces
8. Ready to fire BAR weighs - approximately 21 lbs.
9. A fully automatic weapon - can be fired single shot depending on the proficiency of the gunner.
10. Two cyclic rates of fire - Slow 350 rds per min.  
Normal 550 rds per min.
11. Effective rate (depending on the dexterity of rifleman in changing magazines) is 120 to 150 rds per min.
12. Sustained rate of fire - 40-60 rds per min (long period)

TAKE NOTES HERE:

# B. A. R.

## I. Nomenclature

### A. steps in disassembling the weapon

1. make sure the weapon is cocked
2. turn the gas cylinder port lock pin 180° and pull out.
3. remove the gas cylinder.
4. hold back the operating rod and take out the trigger housing group.
5. remove the trigger housing pin.
6. take out the operating port spring and operating rod pin.
7. remove the pin that holds the hammer in.
8. remove the hammer
9. remove the operating rod and the operating rod handle.
10. raise the pin like deal on the side of the weapon. (bolt assembly guide pin)
11. remove the bolt

II. Uses the new 7.62 Nato cartridge

III. Most effective firing is a burst of live rounds

U.S. RIFLE .30

(Garand Semi-automatic Rifle)

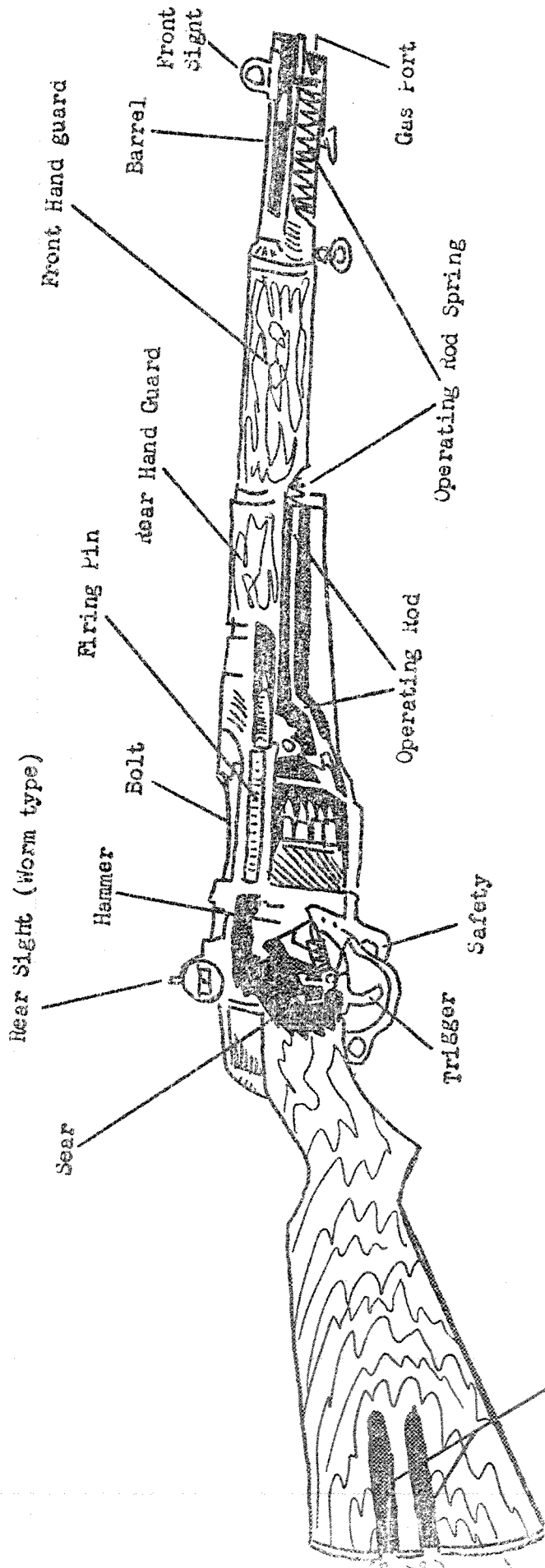

\*THREE MAIN GROUPS COMPOSE THIS WEAPON:

- 1. Barrel and Receiver Group
- 2. Trigger Housing Group
- 3. Stock Group